



XYEK508&EEK508

250V 16A 2.5mm²

Poles: 4P\6P

Pitch: 5.08mm

Pin Dimension: 0.8X1.0mm

Materials

Housing: Polyamide 6.6

Solder Pin: Brass,0.8t, Tin Plated.

Screw: M2.5,Steel, Zinc Plated.

Wire Cage: Steel,0.7t,Zinc Plated.

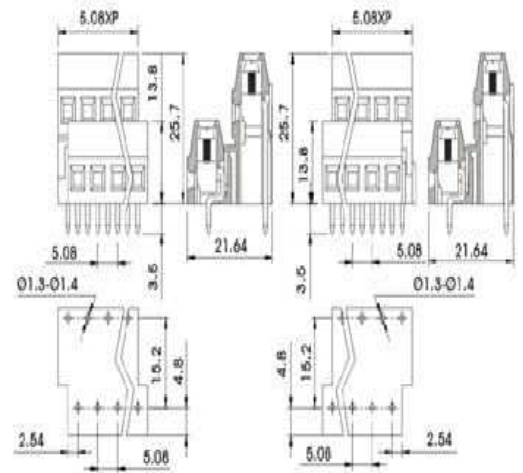



XY128R-A

250V 16A 2.5mm²

Poles: 2P\3P\4P\5P

Pitch: 5mm&10mm

Pin Dimension: 0.8X0.9mm

Materials

Housing: Polyamide 6.6

Solder Pin: Brass,0.8t,Tin Plated.

Screw: M2.5,Steel,Zinc Plated.

Wire Cage: Steel,0.7t,Zinc Plated

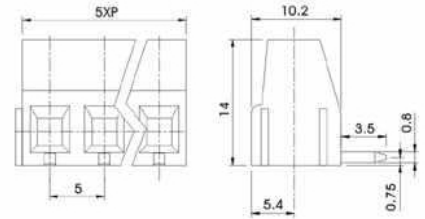



XY129V-B

400V 24A 4.0mm²

Poles: 2P\3P

Pitch: 5mm&10mm

Pin Dimension: 0.9X1.2mm

Materials

Housing: Polyamide 6.6

Solder Pin: Brass,0.9t,Tin Plated.

Wire Cage: Brass,Tin Plated.

Screw: M3.0,steel,Zinc Plated.

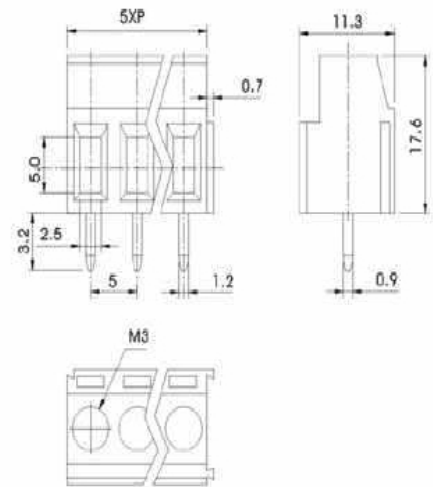



XY2500R-C

250V 12A

Poles: any poles(2P~24P)

Pitch: 5.08mm&10.16mm

Pin Dimension: 1.0X1.0mm

Materials

Housing: Polyamide 6.6

Solder Pin: Brass, 1.0t, Tin Plated.

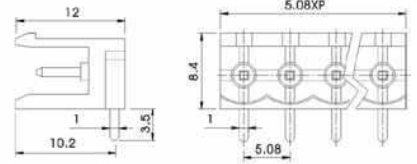



XY304V

250V 16A 1.5mm²

Poles: 2P\3P

Pitch: 5mm&10mm

Pin Dimension: 0.5X0.9mm

Materials

Housing: Polyamide 6.6

Solder Pin: Brass,0.5t, Tin Plated.

Screw: M3.0,Steel, Zinc Plated.

Wire Cage: Brass,Tin Plated.

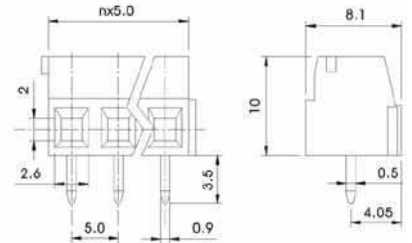



XY126

250V 10A 2.0mm²

Poles: 2P&3P

Pitch: 5mm&10mm

Pin Dimension: 0.6X1.0mm

Materials

Housing: Polyamide 6.6

Solder Pin: Brass,0.6t,Tin Plated.

Wire Cage: Brass,0.6t,Zinc Plated.

Screw: M2.5,Steel,Zinc Plated.

Wire Protector: 0.2t,Stainless steel.

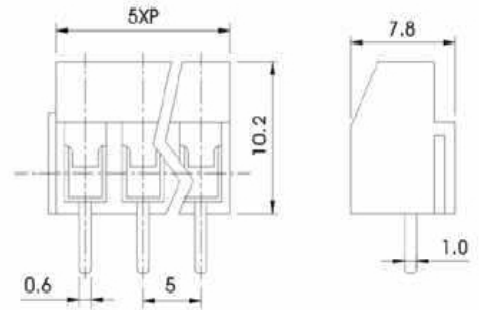

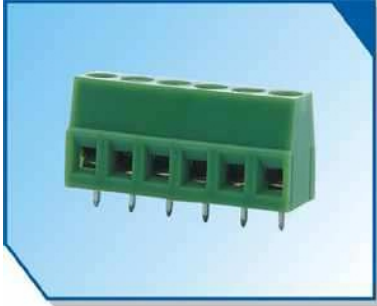

XY128V-A

250V 16A 2.5mm²

Poles: 2P\3P\4P\5P

Pitch: 5mm&10mm

Pin Dimension: 0.8X0.9mm

Materials

Housing: Polyamide 6.6

Solder pin: Brass,0.8t,Tin Plated.

Screw: M2.5,Steel,Zinc Plated.

Wire Cage: Steel,0.7t,Zinc Plated.

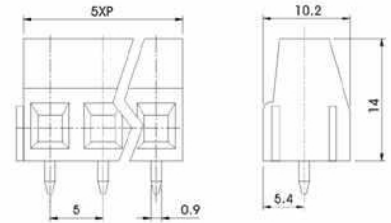

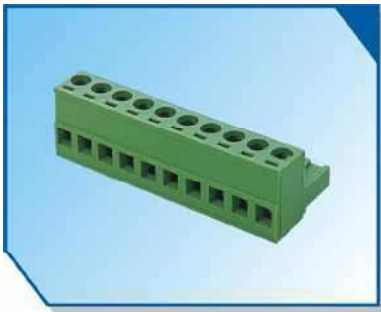

XY2500F-B

250V 12A 2.5mm²

Poles: any poles(2P~24P)

Pitch: 5.08mm&10.16mm

Pin Dimension: 1.0X1.0mm

Materials

Housing: Polyamide 6.6

Clamp: Phosphor Bronze,0.4t,Tin Plated.

Wire Cage: Steel,0.7t,Zinc Plated.

Screw: M2.5,steel,Zinc Plated.

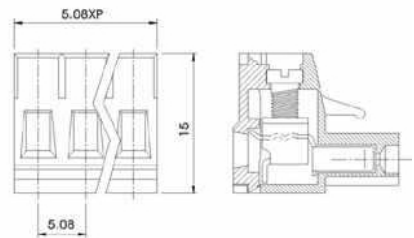

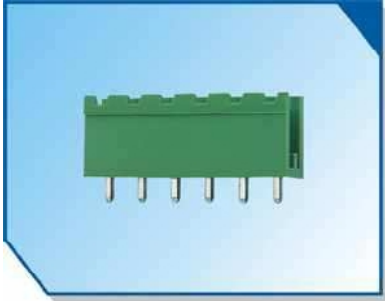

XY2500V-C

250V 12A

Poles: any poles(2P~24P)

Pitch: 5.08mm&10.16mm

Pin Dimension: 1.0X1.0mm

Materials

Housing: Polyamide 6.6

Solder Pin: Brass,1.0t,Tin Plated.

